

SC030N65Y4

55 Amps,650 Volts N-Channel Sic Power MOSFET

Features

- 55A,650V, $R_{DS(ON)MAX}=50m\ \Omega$ @ $V_{GS}=18V/25A$
- High Blocking Voltage with low On-Resistance
- High Speed Switching with Low Capacitance
- Fast Intrinsic Diode with Low Reverse Recovery(Qrr)

Benefits

- Higher System Efficiency
- Reduced Cooling Requirements
- Increased Power Density
- Increased System Switching Frequencytance
- Easy to Parallel and Simple to Drive
- Enable Totem-Pole PFC Topologies

Applications

- Solar Inverters
- Server Power Supplies
- Solar PV Inverters
- UPS
- DC/DC Converters

TO-247-4L

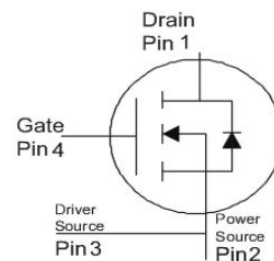
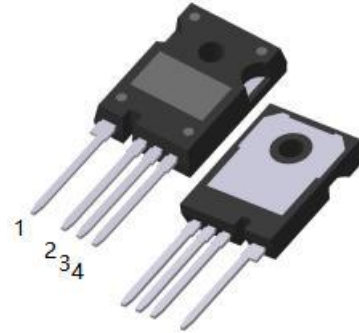

Absolute Maximum Ratings($T_c=25^\circ C$, unless otherwise noted)

Parameter	Symbol	Value	UNIT	Test Conditions
Drain-Source Voltage	V_{DSmax}	650	V	$V_{GS}=0V, I_{DS}=100\mu A$
Gate-Source Voltage(dynamic)	V_{GSmax}	-8/+22		Absolute maximum values
Gate-Source Voltage (static)	V_{GSop}	-4/+18		Recommended operational values
Continuous Drain Current	I_D	55	A	$V_{GS}=18V, T_c=25^\circ C$
		39		$V_{GS}=18V, T_c=100^\circ C$
Pulsed Drain Current	$I_{D(pulse)}$	197	A	Pulse width t_p limited by T_{Jmax}
Power Dissipation	P_D	187	W	$T_c=25^\circ C, T_J=175^\circ C$
Operating Junction and Storage Temperature Range	T_J, T_{STG}	-40 to +175	$^\circ C$	

Thermal Characteristics

Parameter	Symbol	SC030N65Y4	Units
Typical Junction-to-Case	R_{thJC}	0.8	$^\circ C/W$

Electrical Characteristics ($T_c=25^\circ\text{C}$, unless otherwise noted)						
Parameter	Symbol	Test Conditions	Min	Typ	Max	Units
Drain-Source Breakdown Voltage	BV_{DSS}	$V_{GS}=0V, I_D=100\mu A$	650	—	—	V
Zero Gate Voltage Drain Current	I_{DSS}	$V_{DS}=650V, V_{GS}=0V$	—	1	50	μA
Gate-Body Leakage Current	I_{GSS}	$V_{GS}=22V, V_{DS}=0V$	—	10	250	nA
Gate-Source Threshold Voltage	$V_{GS(th)}$	$V_{DS}=V_{GS}, I_D=10mA$	1.8	2.6	4.3	V
Drain-Source On-State Resistance	$R_{DS(on)}$	$V_{GS}=18V, I_D=25A$	—	30	50	m Ω
		$V_{GS}=18V, I_D=25A, T_J=175^\circ\text{C}$	—	42	—	
Input Capacitance	C_{iss}	$V_{DS}=400V, V_{GS}=0V,$ $f=1.0MHz, V_{AC}=25mV$	—	2000	—	pF
Output Capacitance	C_{oss}		—	180	—	pF
Reverse Transfer Capacitance	C_{rss}		—	19	—	pF
Turn-On Delay Time	$t_{d(on)}$	$V_{DS}=400V, V_{GS}=-4V/18V,$ $I_D=25A, R_g=2.5\Omega, R_L=16\Omega$	—	14	—	ns
Turn-On Rise Time	t_r		—	15	—	ns
Turn-Off Delay Time	$t_{d(off)}$		—	28	—	ns
Turn-Off Fall Time	t_f		—	8	—	ns
Turn-On Switching Energy	E_{ON}	$V_{DS}=400V, V_{GS}=-4V/18V$	—	50	—	μJ
Turn-Off Switching Energy	E_{OFF}	$I_D=50A, R_g=2.5\Omega, L=100\mu H$	—	65	—	μJ
Internal Gate Resistance	R_G	$f=1MHz, V_{AC}=25mV$	—	2.5	—	Ω
Total Gate Charge	Q_g	$V_{DS}=400V, I_D=25A,$ $V_{GS}=-4V/18V$	—	110	—	nC
Gate-Source Charge	Q_{gs}		—	30	—	
Gate-Drain Charge	Q_{gd}		—	32	—	
Reverse Diode Characteristics						
Diode Forward Voltage	V_{SD}	$V_{GS}=-4V, I_{SD}=12.5A$	—	4.2	—	V
		$V_{GS}=-4V, I_{SD}=12.5A, T_J=175^\circ\text{C}$	—	3.8	—	
Continuous Diode Forward Current	I_S	$V_{GS}=-4V, T_C=25^\circ\text{C}$	—	—	45	A
Reverse Recover Time	t_{rr}	$V_R=400V, I_{SD}=25A$	—	25	—	ns
Reverse Recovery Charge	Q_{rr}		—	100	—	nc
Peak Reverse Recovery Current	I_{rrm}		—	5	—	A

RATING AND CHARACTERISTIC CURVES

Figure.1 Output Characteristics $T_j=25^\circ\text{C}$

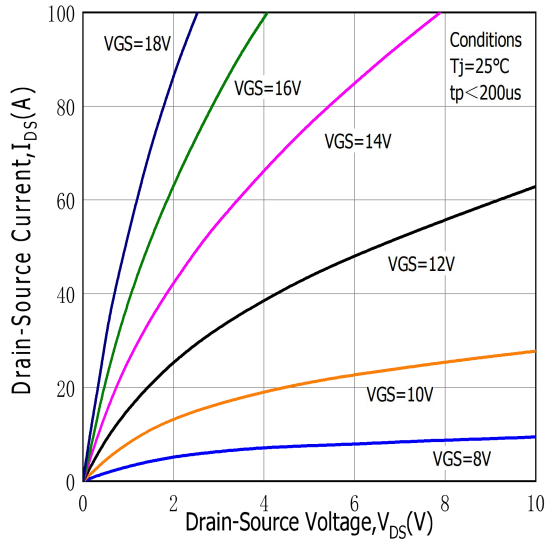

Figure.2 Output Characteristics $T_j=175^\circ\text{C}$

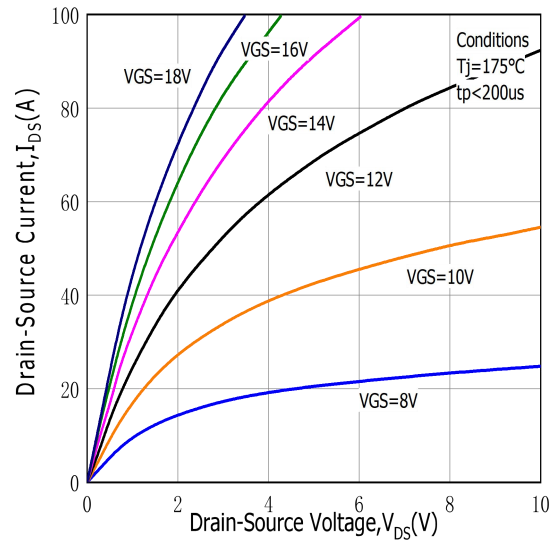

Figure.3 Normalized On-Resistance vs. Temperature

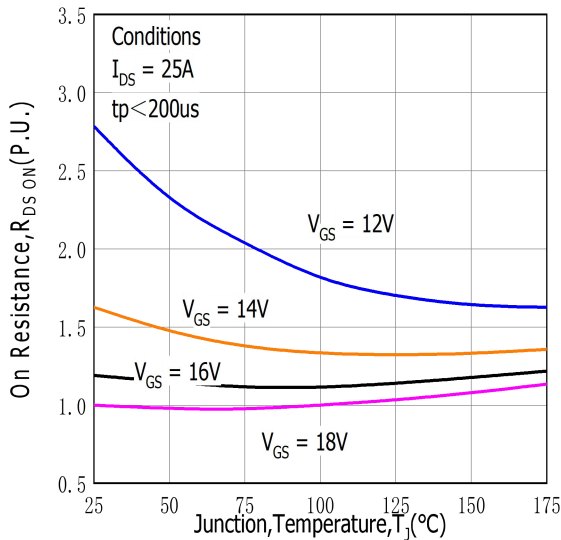

Figure.4 Body Diode Characteristic at 25°C

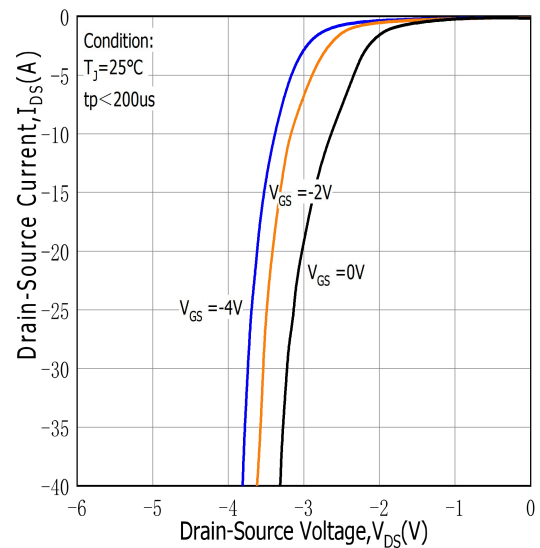

Figure.5 Body Diode Characteristic at 175°C

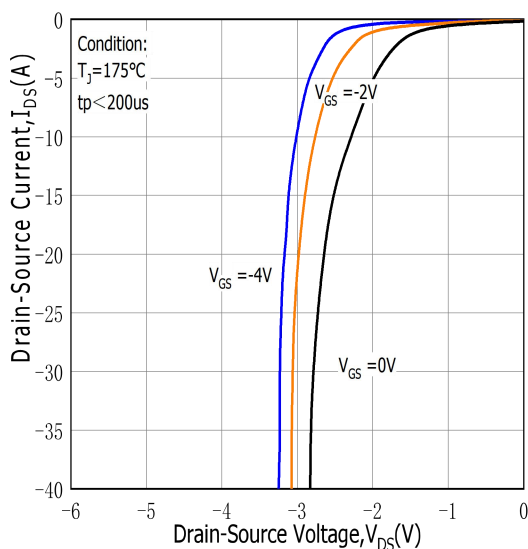

Figure.6 Threshold Voltage vs. Temperature

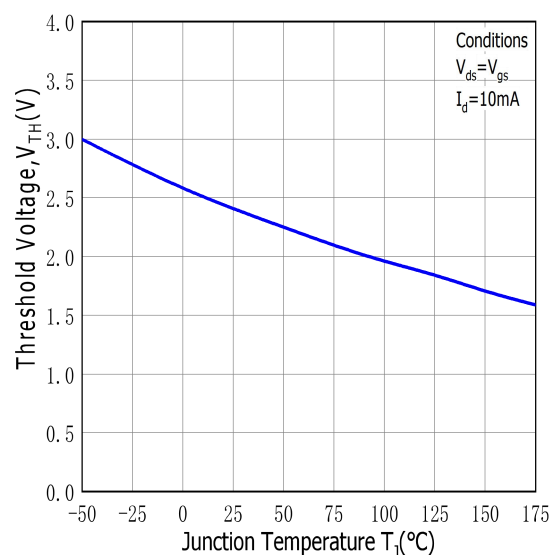

Figure.7 3rd Quadrant Characteristic at 25°C

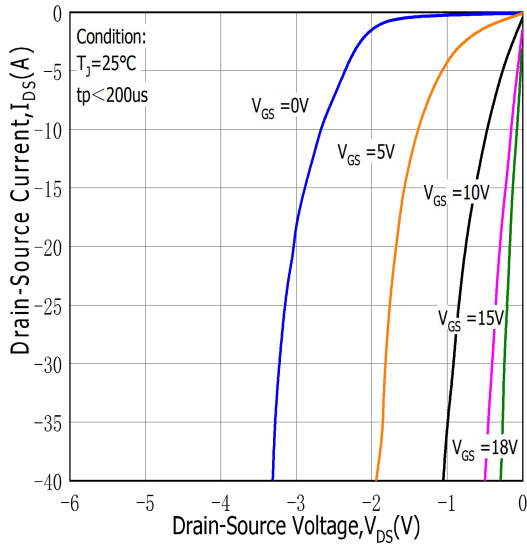

Figure.8 3rd Quadrant Characteristic at 175°C

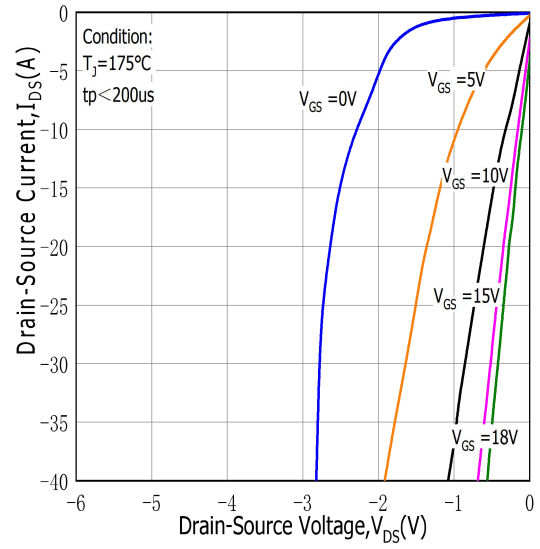

Figure.9 Capacitances vs. Drain-Source Voltage(0-200V)

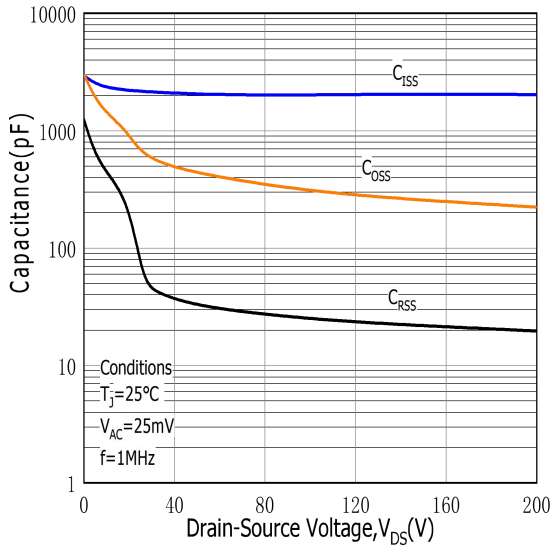
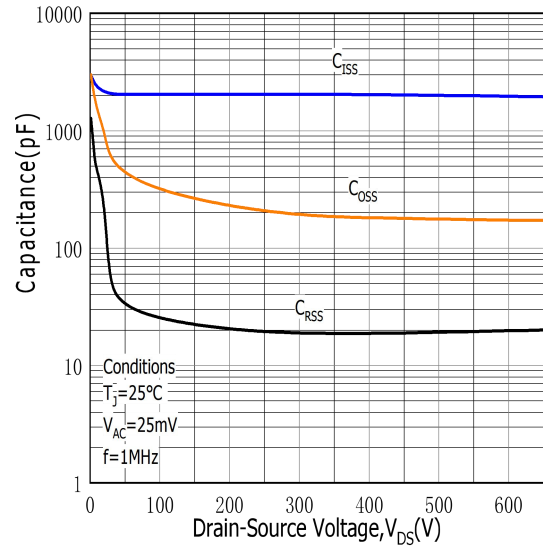
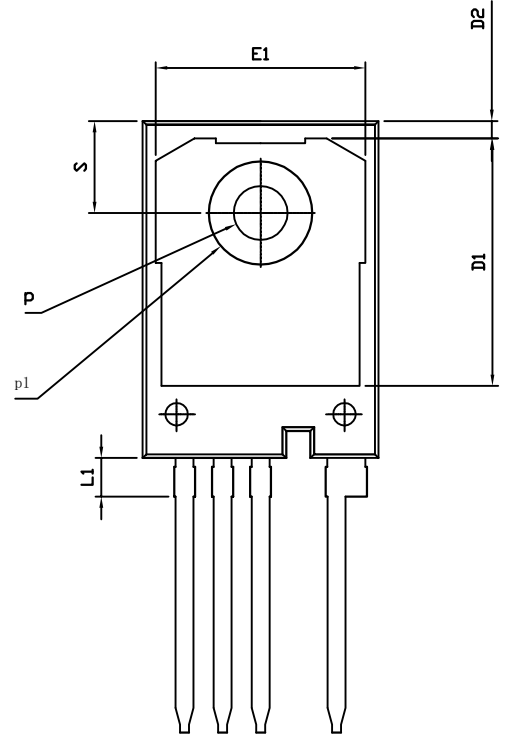
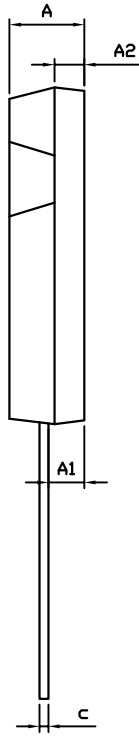
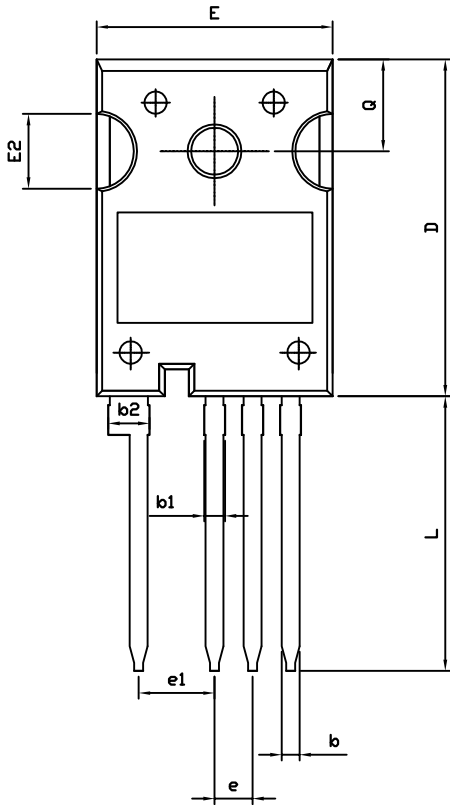

Figure.10 Capacitances vs. Drain-Source Voltage(0-1000V)



TO-247-4L PACKAGE OUTLINE



RECOMMENDED LAND PATTERN

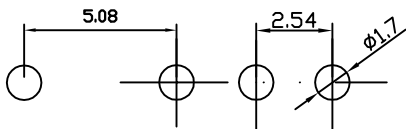

UNIT: mm

	MIN	NOM	MAX
A	4.80	5.00	5.20
A1	2.25	2.40	2.45
A2	1.85	2.00	2.15
b	1.05	1.20	1.35
b1	1.00	1.30	1.60
b2	2.35	2.65	2.95
c	0.50	0.60	0.70
D	22.34	22.54	22.74
D1	16.00	16.50	17.00
D2	0.97	1.17	1.37
e	2.34	2.54	2.74
e1	4.88	5.08	5.28
E	15.60	15.80	16.00
E1	13.50	14.00	14.50
E2	4.80	5.00	5.20
L	18.08	18.38	18.68
L1	2.38	2.58	2.78
p	3.50	3.60	3.70
p1	6.60	6.80	7.00
Q	6.00	6.15	6.30
S	6.00	6.15	6.30